

Lithium Coin Cell - CR 1632 H2

- Low self-discharge
- Long shelf life
- UN 38.3 tested
- Wide assortment of mounting options and wire terminals available



RoHS compliant



Pb free



REACH compliant



Conflict mineral free

SPECIFICATIONS	
Jauch part number	247284
Nominal Voltage	3V
Nominal Capacity	135 mAh
Standard Load	30 kΩ
Standard Current	0.2 mA
Max. Continuous Current	1 mA
Max. Pulse Current	10 mA
Operating Temperature	-30°C to +85°C *
Weight	Approx. 2.1 g
Chemistry	Li/MnO ₂

Note: Capacity 135mAh is obtained at standard cc load to 2.0V at 23°C.

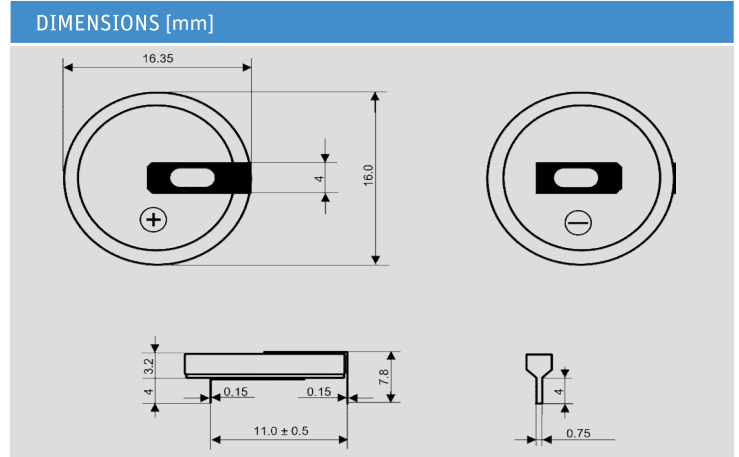

* In applications where the battery is exposed to temperatures >60°C, please contact Jauch.

